

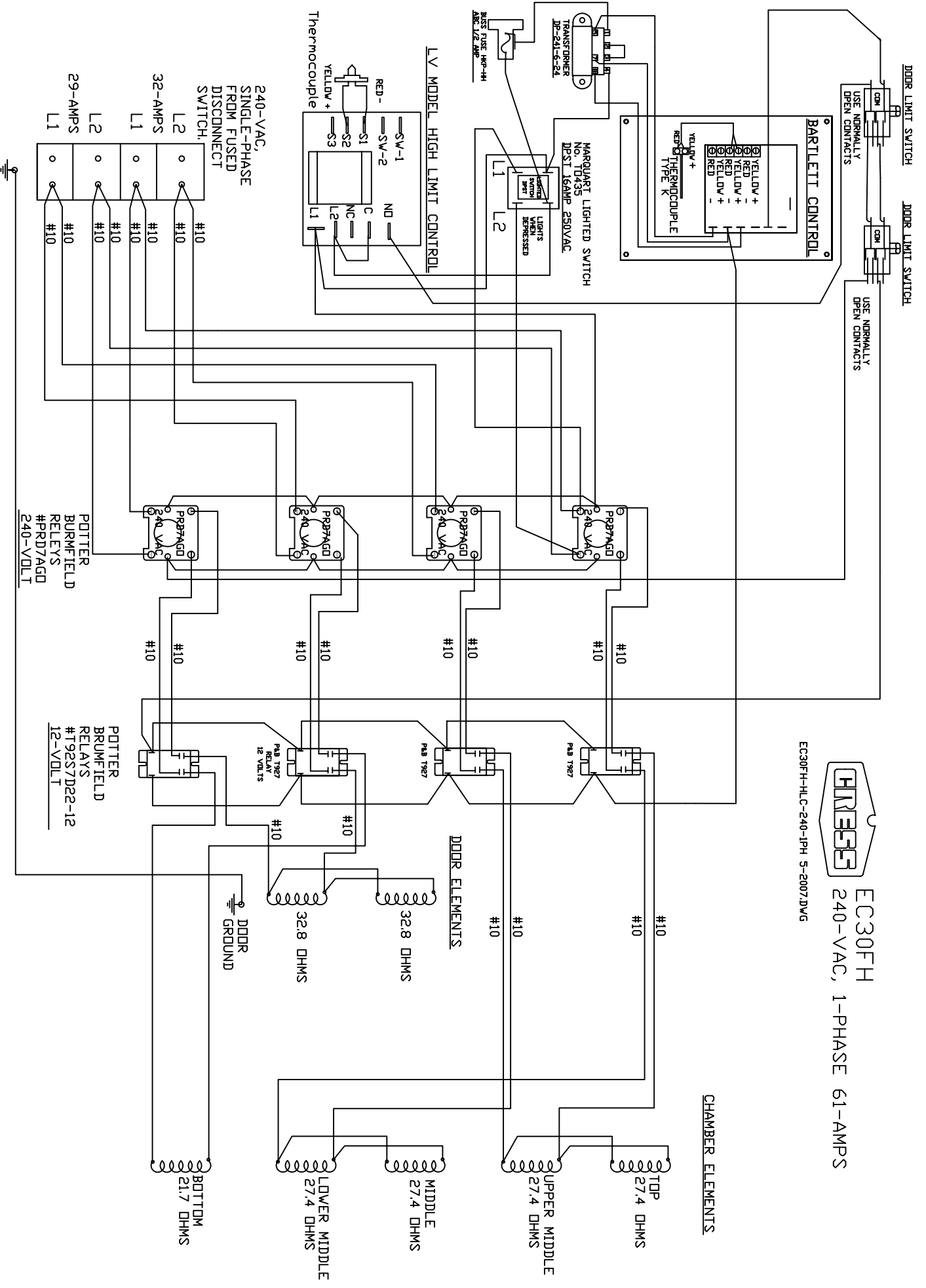

EC30FH
240-VAC, 1-PHASE 61-AMPS

EC30FH-HLC-240-1PH 5-2007.DWG



GROUND TO CASE

WIRE IS #14 GAUGE SF-2, UNLESS OTHERWISE NOTED.