

C-1632/935

208-Volt, Single Phase, 54-Amps

C1632-935-208-1PH.dwg

DOOR LIMIT SWITCHES
PART #ESMS15
2-PCS REQUIRED

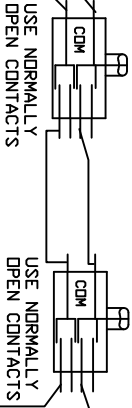

POTTER & BRUMFIELD
RELAY #PRD7AGD,
240-VAC
3-PCS REQUIRED

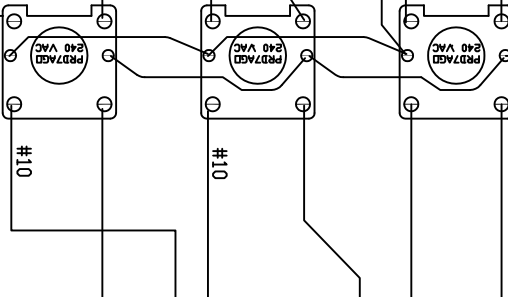

BACK OF FURNACE
ELEMENT CONNECTIONS

ELEMENT RESISTANCE 15.4-OHMS

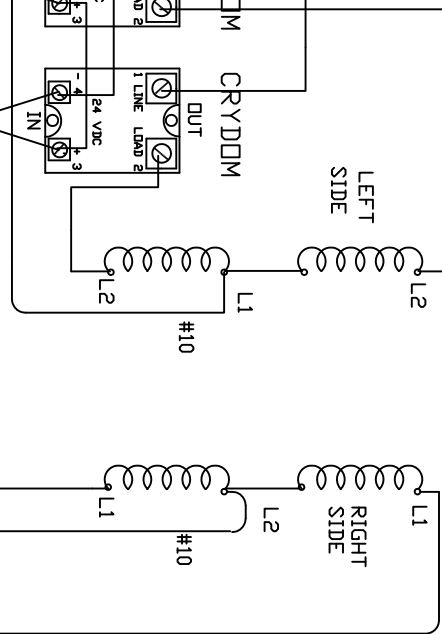

CRYDOM SOLID STATE RELAYS
#ESRT240D25 12-VDC
4-PCS REQUIRED

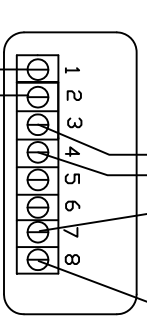
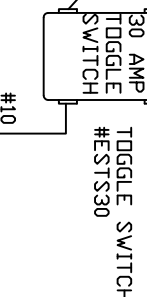
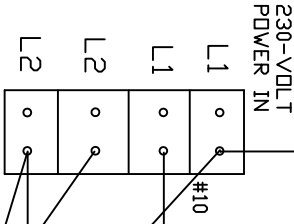
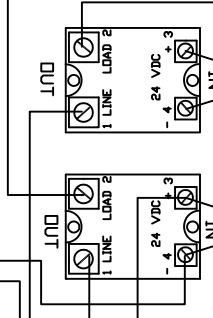

MODEL 935 DIGITAL CONTROL
PART # ECW935

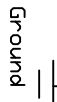

WIRE IS #14 GAGE SF2 UNLESS OTHERWISE SPECIFIED.
T.C. = TYPE 'K' THERMOCOUPLE
G = GROUND

THERMOCOUPLE
PART #TC815