

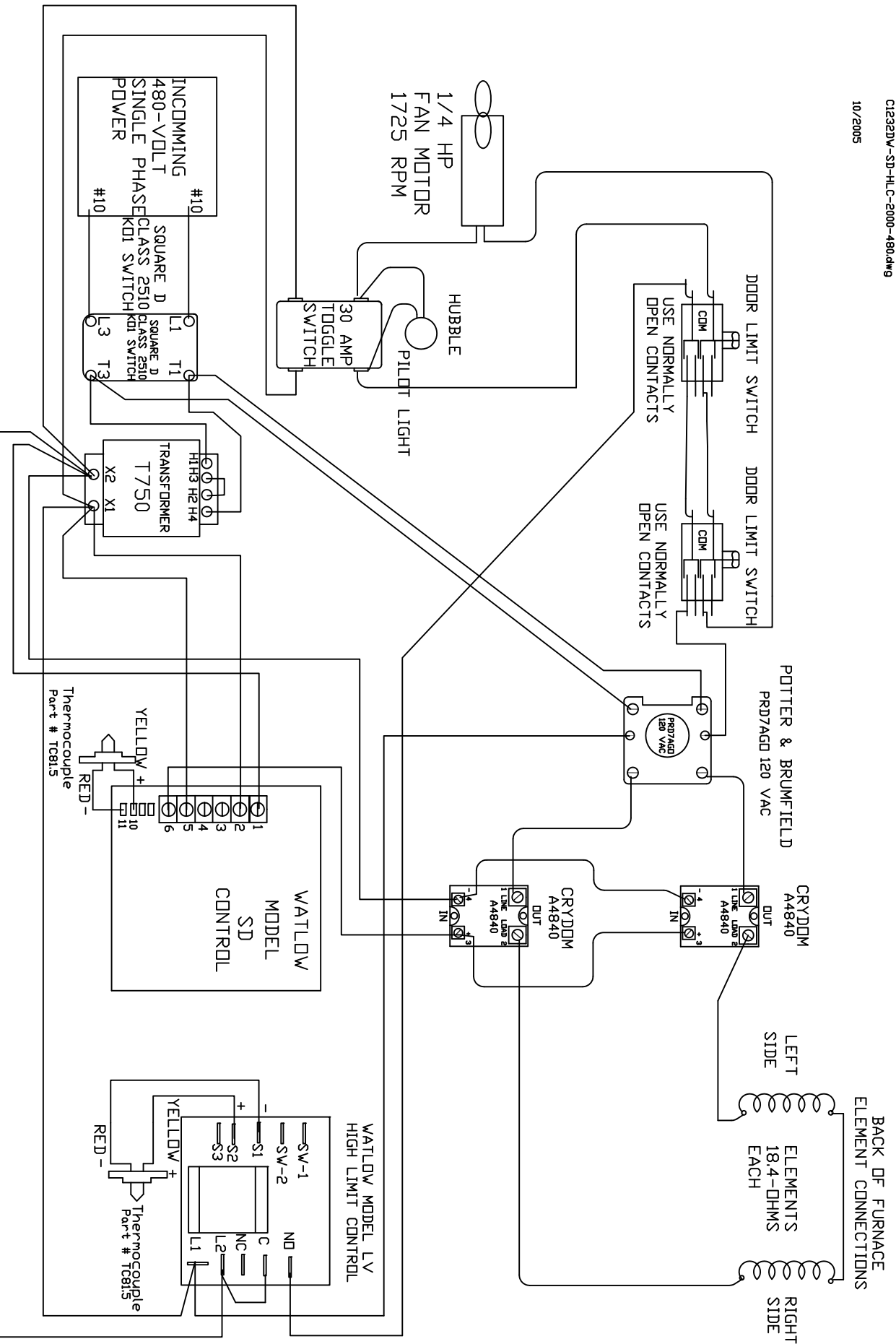

C-1228DW/SD-HLC-2000 480-VOLT, SINGLE-PHASE

C1232DW-SD-HLC-2000-480.dwg
10/2005



WIRE IS #14 GAGE SF2 UNLESS OTHERWISE SPECIFIED.
G = GROUND